



Spec. No.	PS-ND-0712
Rev.	A

PRODUCT SPECIFICATION

Model No : CSS-1116S/CSS-1117S

Descriptions:

- 1.0 Inch Single Digit Alphanumeric Display
- Emitting Color: Super-Bright Red



CUSTOMER APPROVED	APPROVED BY	CHECKED BY	PREPARED BY
SIGNATURES			

CHINA SEMICONDUCTOR CORPORATION
Address:2FL. NO.909,Chung-Cheng Road,
Chung-Ho City Taipei Hsien,Taiwan.

Tel:886-2-2223-9696
Fax:886-2-2223-9377

OPTO PLUS TECHNOLOGIES CO.,LTD
Address:696 Shun jiang Rd.,Ji Shan St.Shaoxing,
ZheJiang,China

Tel:86-0575-8623888
Fax:86-0575-8623112



Spec. No.	PS-ND-0712
Rev.	A

Model No : CSS-1116S/1117S

Features -

1. 1.00 inch (25.4 mm) digit height.
2. Case mold type.
3. RoHs compliant.
4. Low power consumption.
5. Easy mounting on P.C. board or socket.

Device Selection Guide -

Part No.	Chip		Description
	Material	Emitted Color	
CSS-1116S	AlGaAs	Super-Bright Red	Common Anode
CSS-1117S			Common Cathode

Package Dimensions -

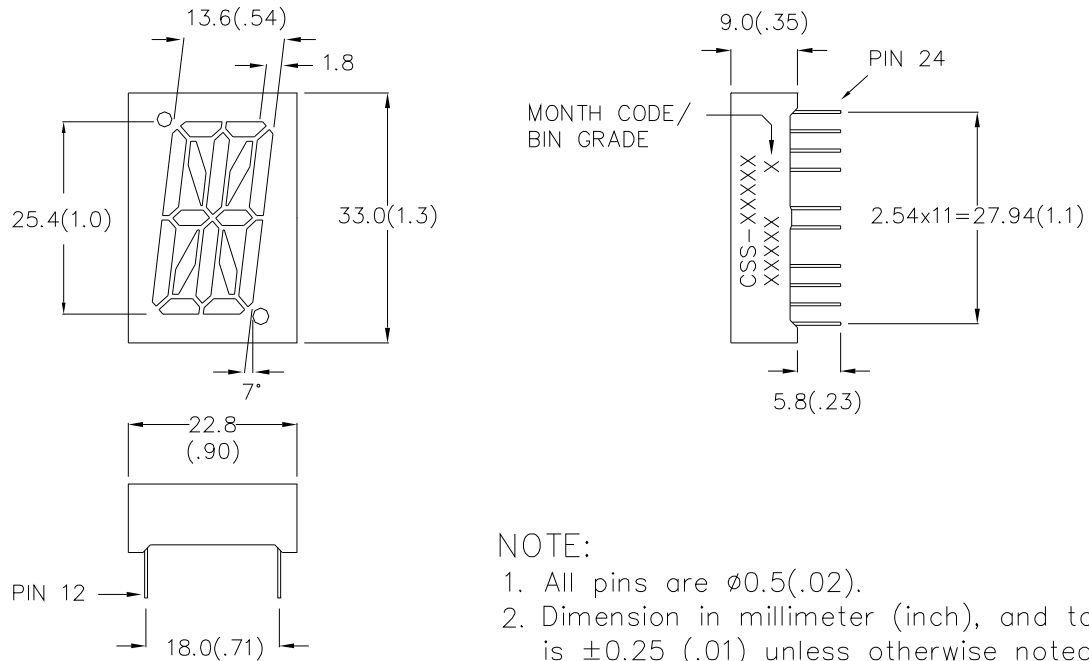

NOTE:

1. All pins are $\phi 0.5(.02)$.
2. Dimension in millimeter (inch), and tolerance is $\pm 0.25 (.01)$ unless otherwise noted.



Spec. No.	PS-ND-0712
Rev.	A

Model No : CSS-1116S/1117S

Internal Circuit Diagrams -

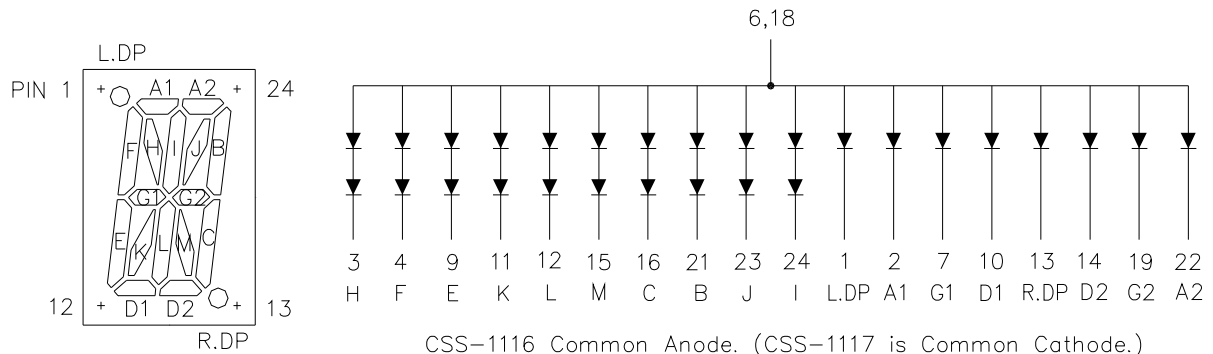

CSS-1116 Common Anode. (CSS-1117 is Common Cathode.)
NO. 5, 8, 17, 20 No Pin.

Absolute Maximum Rating -

(Ta=25°C)

Parameter	Symbol	Rating	Unit
Power Dissipation Per Dice	Pd	75	mW
Continuous Forward Current Per Dice	IAF	30	mA
Peak Current Per Dice (duty cycle 1/10, 1kHz)	IPF	125	mA
Derating Linear From 25°C Per Dice	-	0.42	mA/°C
Reverse Voltage Per Dice	VR	5	V
Operating Temperature	Topr	-25 ~ +85	°C
Storage Temperature	Tstg	-25 ~ +85	°C
Solder temperature 1/16 inch below seating plane for 3 seconds at 260 °C			



Model No : CSS-1116S/1117S

■ Electro-optical Characteristics -

(Ta=25°C)

Parameter	Symbol	Min.	Typ.	Max.	Unit	Condition
Forward Voltage Two Dice (One Dice)	VF	-	3.6(1.8)	5.0(2.5)	V	IF=20mA
Luminous Intensity Per Segment	Iv	-	10	-	mcd	IF=10mA
Peak Emission Wavelength	λ_p	-	660	-	nm	IF=20mA
Spectrum Radiation Bandwidth	$\Delta \lambda$	-	20	-	nm	IF=20mA
Reverse Current	IR	-	-	100	μA	VR=10V
Luminous Intensity Matching Ratio	IV-m	-	-	2 : 1	-	IF=20mA



Spec. No.	PS-ND-0712
Rev.	A

Model No : CSS-1116S/1117S

Typical Electrical / Optical Characteristics Curves -

(Ta = 25°C Unless Otherwise Noted)

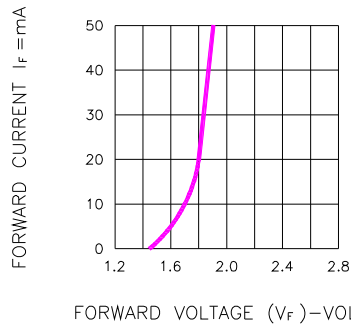

Fig.1 FORWARD CURRENT VS. FORWARD VOLTAGE

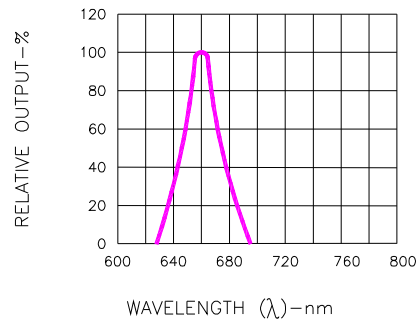

Fig.2 SPECTRAL RESPONSE

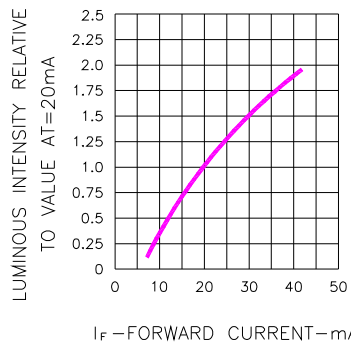

Fig.3 RELATIVE LUMINOUS INTENSITY VS. FORWARD CURRENT

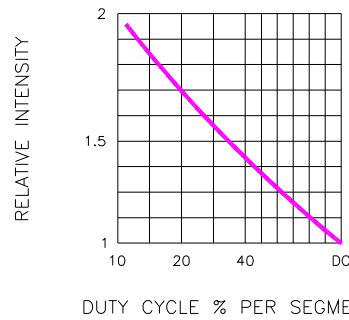

Fig.5 LUMINOUS INTENSITY VS. DUTY CYCLE

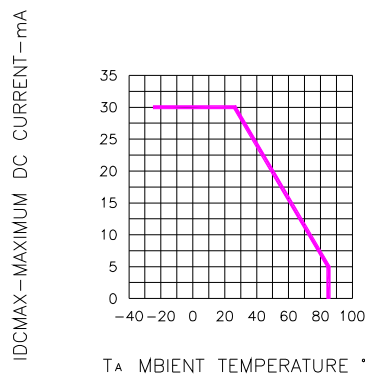

Fig.4 MAXIMUM ALLOWABLE DC CURRENT PER SEGMENT VS. AMBIENT TEMPERATURE

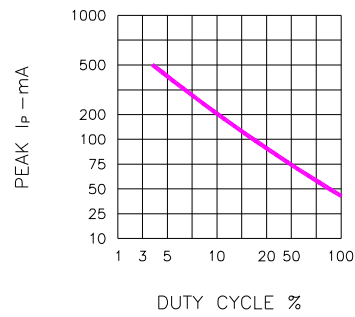

Fig.6 MAX PEAK CURRENT VS. DUTY CYCLE % (REFRESH RATE f=1 KHz)



**CHINA
SEMICONDUCTOR
CORPORATION**

Spec. No.	PS-ND-0712
Rev.	A

Model No : CSS-1116S/1117S

Package Dimensions

S = Single Digit Display
Dice Code
CSS-1116X-21
Segment Resin Color Code. 1=White Segment.
Surface silk Screen Ink Code. 2=Black (1=Gray).

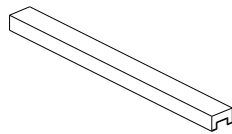

1 TUBE From Box = 15 PCS

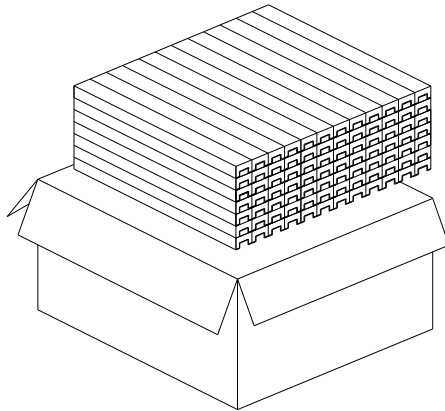

1 BOX= 50 TUBE From Box
Q'TY: 750 PCS.



1 CARTON = 3 BOX.

Q'TY: 2250 PCS.

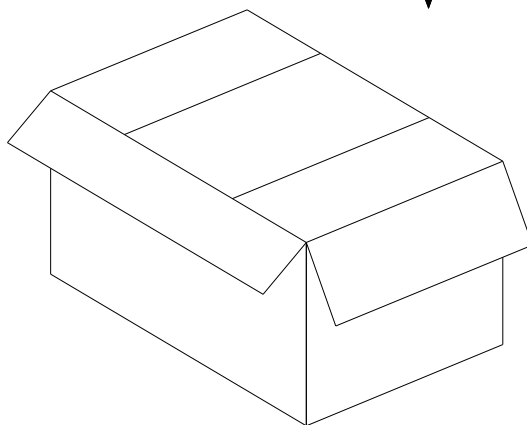

**CARTON SIZE:
L540xW485xH305mm**

Note: The specifications are subject to change without notice. Please contact us for updated information.
